



Model number

V1S-W-2M-PUR

Cable connector, M12, 4-pin, PUR cable

Features

- Knurled nut suitable for tool assembly
- Immunity to vibration, with mechanical latching
- Gold plated contacts
- Protection degree IP67 / IP68 / IP69K
- Halogen-free
- Suitable for 2-, 3- and 4-wire technology

Dimensions

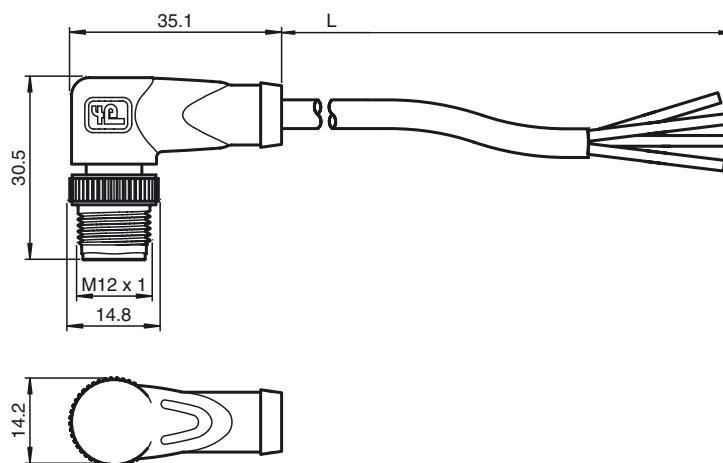

Technical data

General specifications

Number of poles	4
Connection 1	Connector, male
Construction type 1	angled
Threading 1	M12
Connection 2	free cable end

Electrical specifications

Operating voltage	max. 300 V DC
Test voltage	> 1500 V _{eff} AC
Operating current	max. 4 A
Volume resistance	< 5 mΩ

Ambient conditions

Ambient temperature	-25 ... 100 °C (248 ... 373 K) for temperatures over 80 °C (353 K) reduced elongation at tear
Degree of soiling	3

Mechanical specifications

Contact elements	spring-loaded contact socket
pin diameter	1 mm
Protection degree	IP67 / IP68 / IP69K
Material	
Contacts	CuSn / Au
Contact surface	Au
Handle	TPU, green
Cable	PUR
(Cap??-translator) connector	diecast zinc
Core isolation	PP
Cable	fine-strand, flexible
Sheath diameter	Ø4.8 mm
Bend radius	> 10 x conductor diameter, appropriate for conveyor chains
Colour	grey
Cores	4 x 0.34 mm ²
Conductor construction	19 x 0.15 mm Ø
Length	L 2 m
Flammability	
Contact material	94V-2
Housing	94V-2

Electrical connection 1

