

US 60 K 1000 PSI-I-TSSL

Ultrasonic Sensor

- Robust casing
- Compact design
- Scanning range adjustable
- Insensitive to dirt
- Insensitive to ambient noise
- Scanning does not depend on surface
- Switching output and analog output
- High follow-up speed
- High resolution
- Piezo-ceramic composite transducer

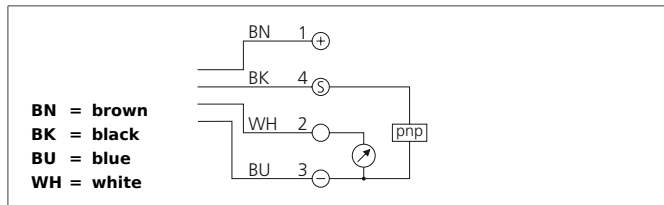

Safety instructions

The Instruments are not to be used for safety applications, in particular applications in which safety of persons depends on proper operation of the instruments.
 These instruments shall exclusively be used by qualified personnel.
 Repair only by di-soric.

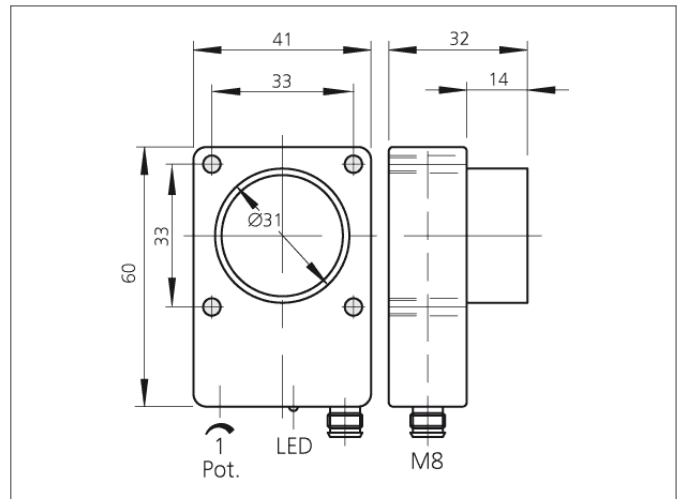

TECHNICAL INFORMATION		+20°C, 24V DC
Operating principle		Ultrasonic sensor
Size		60 x 41 x 18 mm (Dimensions)
Design		cuboid design
Service voltage		15 ... 30 V DC
Operating distance		135 ... 1.000 mm
Resolution		0,2 % / Sn max.
Switching output		Transistor pnp, 100 mA, NO + analog
Analog output		17,8 ... 4 mA
Tracking speed		250 ms (95% Sn max.)
Operating frequency		180.000 Hz
Ripple		20 mV
Linearity analog output		< 0,5 % / Sn max.
Internal power consumption		80 mA
Operating frequency		5 Hz
Accuracy		< 1 % / Sn max.
Response-/release time		130 ms / 90 ms (50% Sn max.)
Switching hysteresis		25 mm
Ambient temperature		-20 ... +50 °C
Temperature error		1 % (-20 ... +50°C)
Load resistance		< 400 Ω
Insulation voltage endurance		500 V
Protection class		IP 67
Casing material		polyamide

US 60 K 1000 PSI-I-TSSL

Ultrasonic Sensor

TECHNICAL INFORMATION

Connection

+20°C, 24V DC

Connector, M8, 4-poled