

Capacitive Proximity Switches 20... 250 VAC

Output Schematics

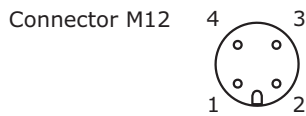

M18 M18 M18 M18

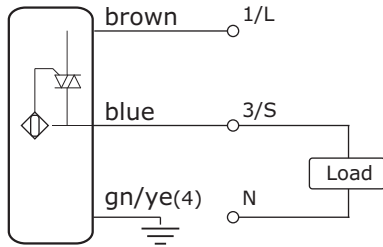

8 mm

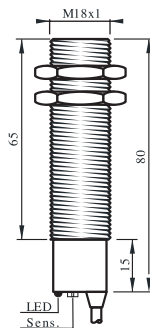

15 mm

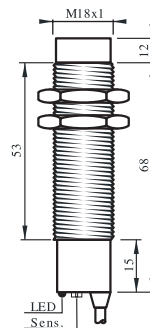

8 mm

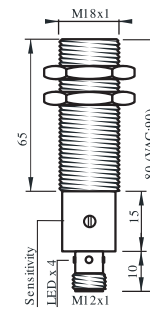

15 mm

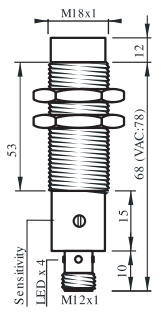

SPECIFICATIONS

	M18x1	M18x1	M18x1	M18x1
Sensing Distance (Sn)	8 mm - Shielded	15 mm - Unshielded	8 mm - Shielded	15 mm - Unshielded
Operating Voltage	20... 250 VAC, 2-wire	20... 250 VAC, 2-wire	20... 250 VAC, 2-wire	20... 250 VAC, 2-wire
Reverse Polarity Protection	not required	not required	not required	not required
Current Consumption	< 2 mA (Idle Current)	< 2 mA (Idle Current)	< 2 mA (Idle Current)	< 2 mA (Idle Current)
Current Load Capability	400 mA	400 mA	400 mA	400 mA
Short Circuit Protection	-	-	-	-
Voltage Drop	8 V @ 400 mA	8 V @ 400 mA	8 V @ 400 mA	8 V @ 400 mA
Adjustment	Adjustable, Multi-Turn	Adjustable, Multi-Turn	Adjustable, Multi-Turn	Adjustable, Multi-Turn
Switching Frequency	25 Hz	25 Hz	25 Hz	25 Hz
Repeatability	< 4 %	< 4 %	< 4 %	< 4 %
Hysteresis	3...15 %	3...15 %	3...15 %	3...15 %
Operating Temperature	-25...+70 °C	-25...+70 °C	-25...+70 °C	-25...+70 °C
Temperature Drift	< 10 % (Sn)	< 10 % (Sn)	< 10 % (Sn)	< 10 % (Sn)
Protection Class	IP 67	IP 67	IP 67	IP 67
Housing Material	Plated Brass	Plated Brass	Plated Brass	Plated Brass
Connection	2m, PVC	2m, PVC	Connector M12, 4-pole	Connector M12, 4-pole
Output Indicator	Integrated	Integrated	Integrated	Integrated
Article Code				

2-wire+Ground NO, 20...250 VAC
2-wire+Ground NC, 20...250 VAC

CS18-S8A090/A2P
CS18-S8AC90/A2P

CS18-N15A090/A2P
CS18-N15AC90/A2P

CS18-S8A090/M12
CS18-S8AC90/M12

CS18-N15A080/M12
CS18-N15AC80/M12

Capacitive Proximity Switches

20... 250 VAC

CAPACITIVE

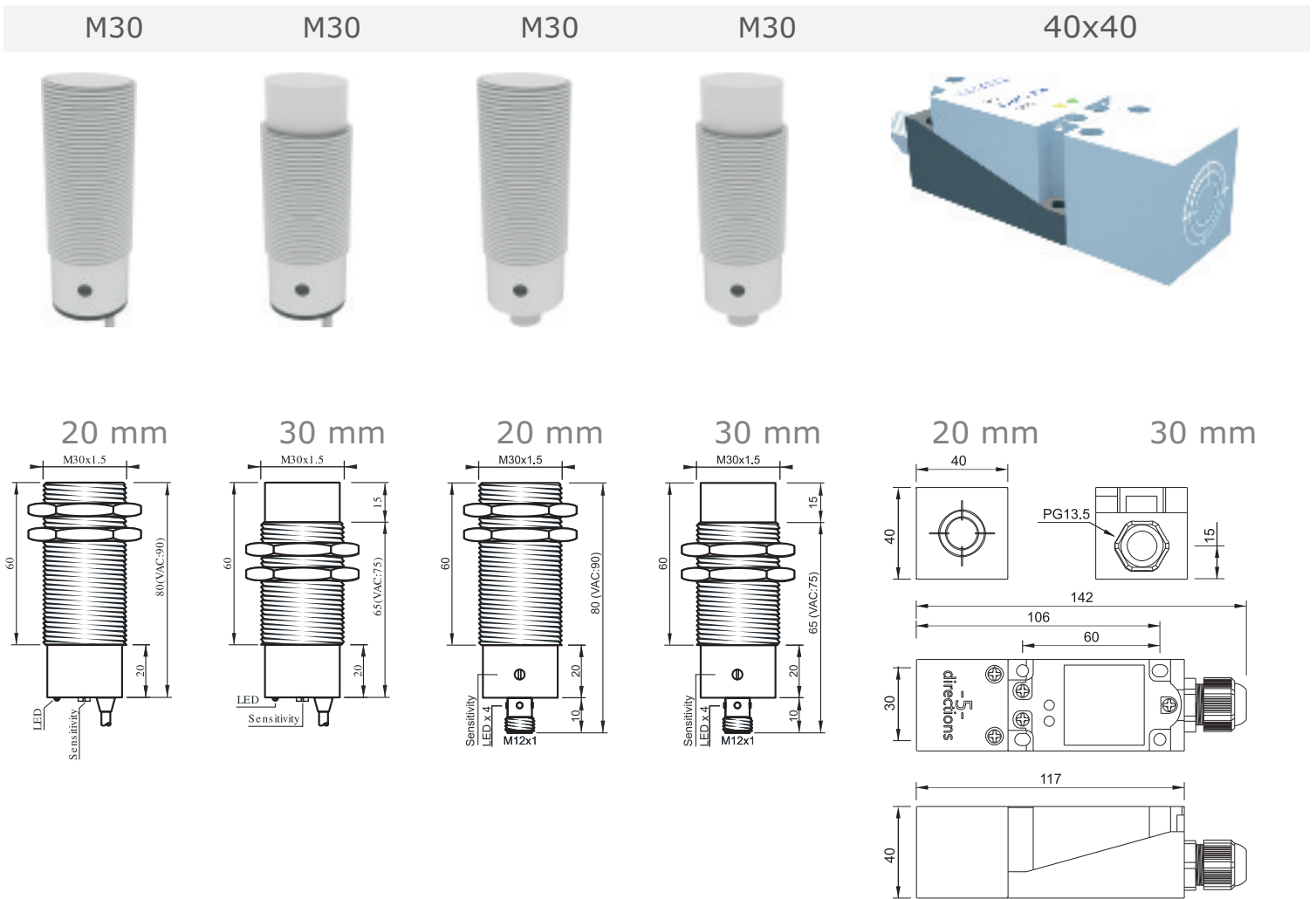

M30x1.5	M30x1.5	M30x1.5	M30x1.5	40x40 mm	40x40 mm
20 mm - Shielded	30 mm - Unshielded	20 mm - Shielded	30 mm - Unshielded	20 mm - Shielded	30 mm - Unshielded
20... 250 VAC, 2-wire not required	20... 250 VAC, 2-wire not required	20... 250 VAC, 2-wire not required	20... 250 VAC, 2-wire not required	20... 250 VAC, 2-wire not required	20... 250 VAC, 2-wire not required
< 2 mA (Idle Current)	< 2 mA (Idle Current)	< 2 mA (Idle Current)	< 2 mA (Idle Current)	< 2 mA (Idle Current)	< 2 mA (Idle Current)
400 mA	400 mA	400 mA	400 mA	400 mA	400 mA
-	-	-	-	-	-
8 V @ 400 mA	8 V @ 400 mA	8 V @ 400 mA	8 V @ 400 mA	8 V @ 400 mA	8 V @ 400 mA
Adjustable, Multi-Turn	Adjustable, Multi-Turn	Adjustable, Multi-Turn	Adjustable, Multi-Turn	Adjustable, Multi-Turn	Adjustable, Multi-Turn
25 Hz	25 Hz	25 Hz	25 Hz	25 Hz	25 Hz
< 4 %	< 4 %	< 4 %	< 4 %	< 5 %	< 5 %
3...15 %	3...15 %	3...15 %	3...15 %	3...15 %	3...15 %
-25...+70 °C	-25...+70 °C	-25...+70 °C	-25...+70 °C	-25...+70 °C	-25...+70 °C
< 10 % (Sn)	< 10 % (Sn)	< 10 % (Sn)	< 10 % (Sn)	< 10 % (Sn)	< 10 % (Sn)
IP 67	IP 67	IP 67	IP 67	IP 67	IP 67
Plated Brass	Plated Brass	Plated Brass	Plated Brass	PBT	PBT
2m, PVC	2m, PVC	M12, 4-polos	M12, 4-polos	PG13.5, Terminal	PG13.5, Terminal
Integrated	Integrated	Integrated	Integrated	Integrated	Integrated

CS30-S20AO90/A2P CS30-N30AO80/A2P CS30-S20AO80/M12 CS30-N30AO80/M12 CS40-S20AOL/PG13 CS40 N30AOL/PG13
 CS30-S20AC90/A2P CS30-N30AC80/A2P CS30-S20AC80/M12 CS30-N30AC80/M12 CS40-S20ACL/PG13 CS40 N30ACL/PG13